

# Loftssystemer















C90-R monteret i Dampa Clip-In

# Indhold

|   |             |
|---|-------------|
| <b>Oversigt</b>                                       | <b>3</b>    |
| <b>Modullofter</b>                                    | <b>4-16</b> |
| Synligt skinnesystem                                  | 4-5         |
| Synligt skinnesystem med profilerede plader           | 6-7         |
| Synligt skinnesystem med kantede loftplader           | 8           |
| Skjult skinnesystem med symmetriske loftplader        | 9           |
| Skjult 24 mm skinnesystem med asymmetriske loftplader | 10-11       |
| Skjult 35 mm skinnesystem med asymmetriske loftplader | 12          |
| Bæreskinne 16 mm                                      | 13          |
| Bæreskinne 36 mm                                      | 14          |
| Bæreskinne 45 mm                                      | 15          |
| Ikke demonterbare                                     | 16          |
| <b>Gipslofter</b>                                     | <b>17</b>   |
| <b>Panellofter, flåde</b>                             | <b>18</b>   |
| <b>Panellofter</b>                                    | <b>19</b>   |

# Oversigt

|   |                   | MODULLOFTER          |       |                |                |                |                     |                |                |                |                |                | Ikke demonterbare | Gipslofter       |
|---|-------------------|----------------------|-------|----------------|----------------|----------------|---------------------|----------------|----------------|----------------|----------------|----------------|-------------------|------------------|
|   |                   | DEMONTerbare         |       |                |                |                |                     |                |                |                |                |                |                   |                  |
|   |                   | SYNLIGT SKINNESYSTEM |       |                |                |                | SKJULT SKINNESYSTEM |                |                |                |                |                |                   |                  |
|   |                   | 15-24 mm             | 35 mm | 15-24 mm       | 15-24 mm       | 15 mm          | 24 mm               | Asy 24 mm      | Asy 35 mm      | 16 mm          | 36 mm          | 45 mm          |                   |                  |
|    | A51-R G2          | ✓                    | ✓     | ✓              | ✓              | ✓              | ✓ <sup>1</sup>      | ✓ <sup>1</sup> |                | ✓ <sup>1</sup> | ✓ <sup>1</sup> | ✓ <sup>1</sup> |                   |                  |
|    | C25-R G2<br>C35-R | ✓                    | ✓     | ✓              | ✓              | ✓              |                     |                |                |                |                |                |                   | ✓ <sup>3</sup>   |
|    | C30RIT G2         | ✓                    | ✓     | ✓              | ✓              | ✓              |                     |                |                |                |                |                |                   | ✓ <sup>3</sup>   |
|    | C30RIC G2         |                      |       |                |                |                | ✓                   | ✓              | ✓              | ✓              | ✓              | ✓              |                   |                  |
|    | C63-R             | ✓                    | ✓     | ✓              | ✓              |                | ✓                   | ✓              |                | ✓              | ✓              | ✓              |                   |                  |
|  | C64-R             | ✓                    |       | ✓              | ✓              |                | ✓                   |                |                | ✓              |                |                | ✓                 | ✓                |
|  | C70-R G2          | ✓                    | ✓     | ✓              | ✓              | ✓              |                     |                |                |                |                |                | ✓ <sup>2</sup>    | ✓ <sup>2</sup>   |
|  | C77-R             | ✓                    | ✓     | ✓              | ✓              | ✓              | ✓ <sup>1</sup>      | ✓ <sup>1</sup> | ✓ <sup>1</sup> | ✓ <sup>1</sup> | ✓ <sup>1</sup> | ✓ <sup>1</sup> |                   | ✓ <sup>3</sup>   |
|  | C80-R G2          | ✓                    |       |                |                |                | ✓ <sup>1</sup>      | ✓ <sup>1</sup> | ✓ <sup>1</sup> |                |                |                |                   | ✓                |
|  | C90-R             | ✓                    | ✓     | ✓              | ✓              | ✓              | ✓ <sup>1</sup>      |                |                | ✓ <sup>1</sup> | ✓ <sup>1</sup> |                |                   | ✓ <sup>3</sup>   |
|  | C91-R             |                      |       |                |                |                |                     | ✓              |                |                |                | ✓              |                   |                  |
|  | C91-RE            |                      |       | ✓ <sup>4</sup> | ✓ <sup>4</sup> | ✓ <sup>4</sup> |                     |                |                |                |                |                |                   |                  |
|  | C92-R             |                      |       |                |                |                |                     |                | ✓              |                |                |                |                   |                  |
|  | C95-R             | ✓                    | ✓     | ✓              | ✓              | ✓              | ✓ <sup>1</sup>      | ✓ <sup>1</sup> |                | ✓ <sup>1</sup> | ✓ <sup>1</sup> | ✓ <sup>1</sup> | ✓ <sup>1</sup>    | ✓ <sup>3</sup>   |
|  | MODERNA2-R        | ✓                    | ✓     | ✓              | ✓              | ✓              |                     |                |                |                |                |                |                   | ✓ <sup>1/3</sup> |

1 - Med monteringsbeslag som tilbehør  
2 - Med monteringsramme som tilbehør

3 - Med ramme for gipsloft  
4 - Kun på forespørgsel

# Modullofter

Loftsystemer begrænset i både længde og bredde, med enten synlige eller skjulte skinnesystemer.

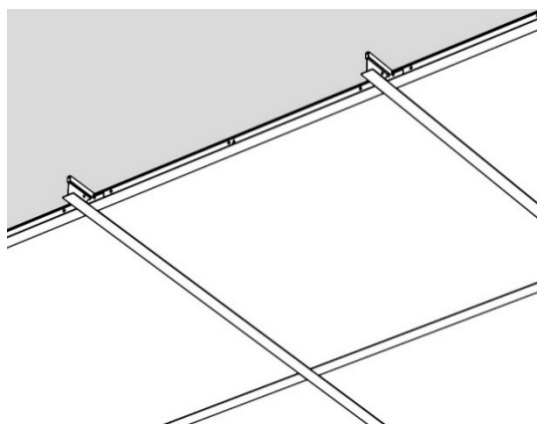

Synligt skinnesystem

---

## Synligt skinnesystem

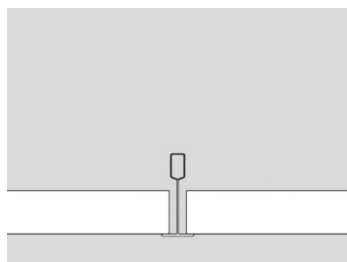

Ecophon A15

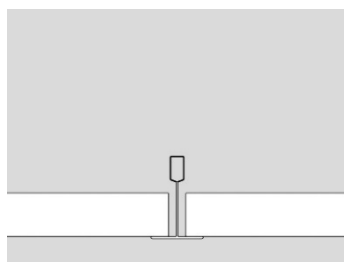

Ecophon A24

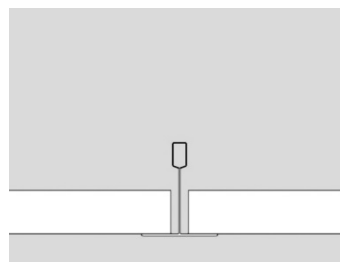

Armstrong Prelude 35

## Eksempel på leverandører

AMF SK 15/24, Armstrong Prelude 15/24/35, Burgess Sequence 15/24, Ecophon A15/24, Gyproc Gyptone A15/24, Knauf Danoline A, Lindner LMD-K 403, OWA S 15/3, Paroc A, Rockfon A15/24, Trolldtekt K0-S 35

## Vores tilpassede løsninger

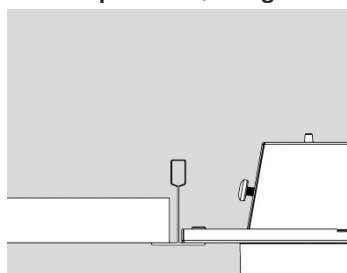

A51-R G2

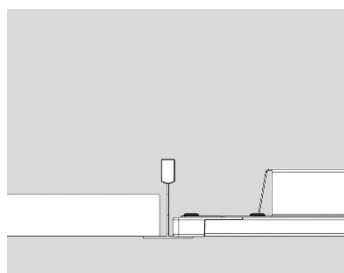

C77-R

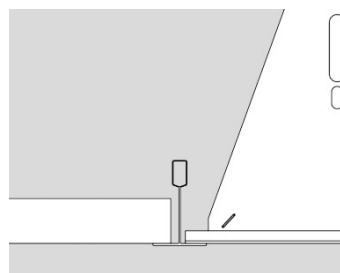

C30-RIT G2

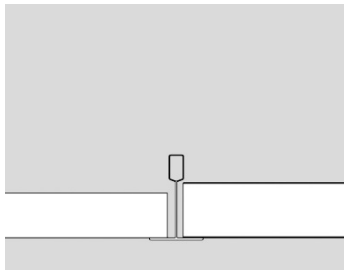

C25-R/C35-R/C95-R/  
MODERNA2-R

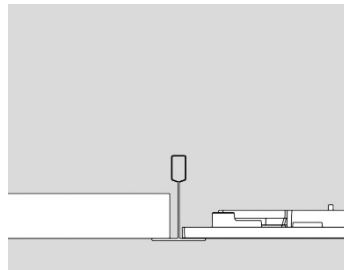

C70-R G2

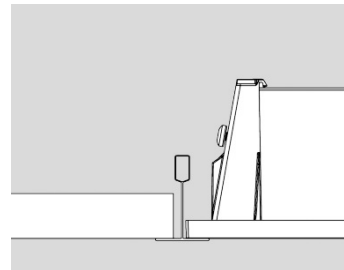

C90-R

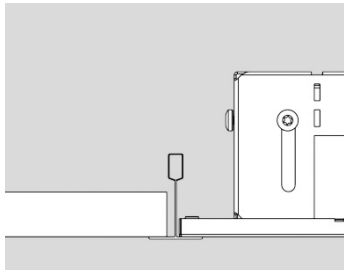

C63-R

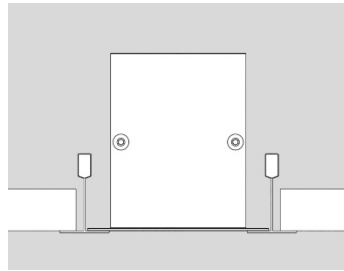

C80-R G2

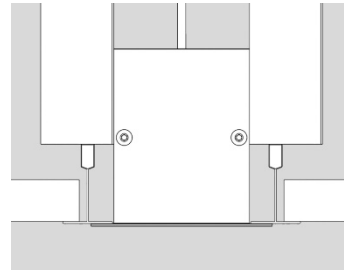

C80-R G2

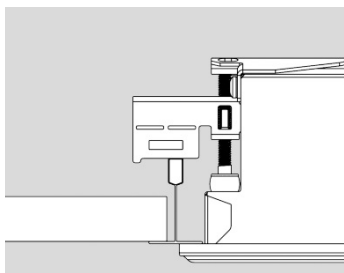

C64-R

Kan kun monteres nedefra i skinessystem ved hjælp af armaturets indbyggede beslag (for at opretholde den høje IP-klasse).

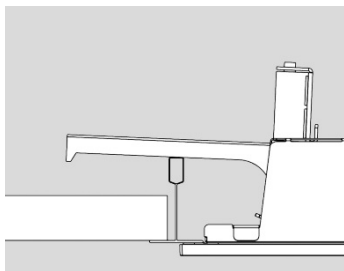

C70-R G2/C85-R  
(+ MNT C70-R G2)

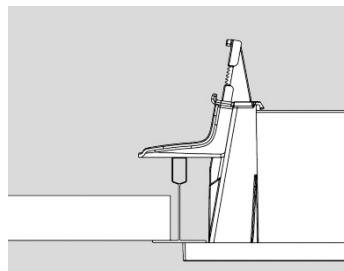

C90-R  
(+ MNT C90-R)

Ønskes montering nedefra, anbefales at bruge C70-R G2 eller C90-R. Monteringsæt er nødvendig som ekstra tilbehør.

## Synligt skinesystem med profilerede plader

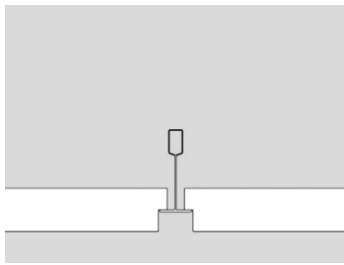

Rockfon E15S

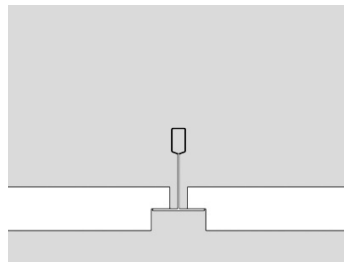

Rockfon E24S

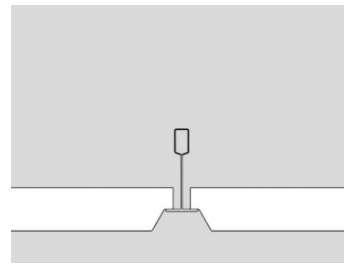

Loftpladernes kant kan variere i form og dybde. Her vist ved Rockfon E15L.

## Eksempel på leverandører

AMF VT 15/24, Armstrong Prelude 15/24, Burgess Sequence 15/24, Ecophon E15/24, Gyproc Gyptone E15, Knauf Danoline E/E+, Lindner LMD-K 400, OWA S 15A/3A, Paroc E15/E24, Rockfon E15/24, Troldekt K0/K3/K5-FS 35

## Vores tilpassede løsninger

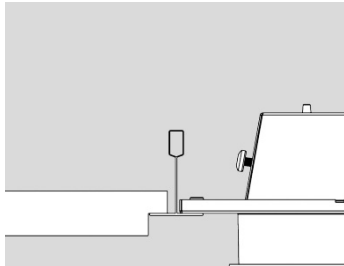

A51-R G2

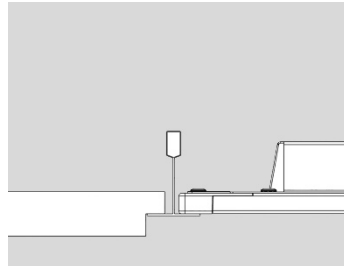

C77-R

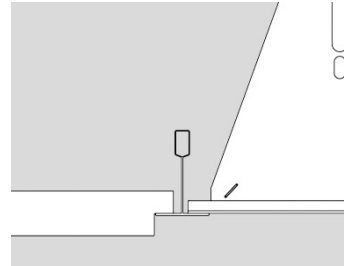

C30-RIT G2

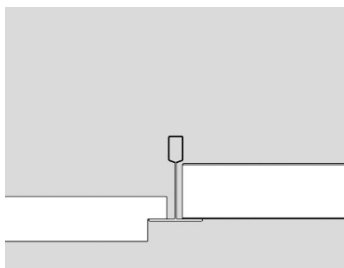

C25-R/C35-R/C95-R/  
MODERNA2-R

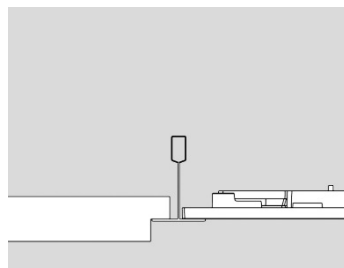

C70-R G2

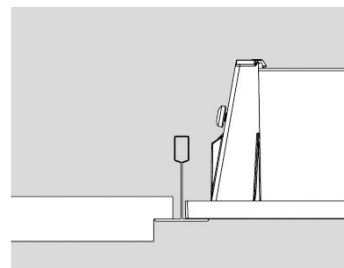

C90-R

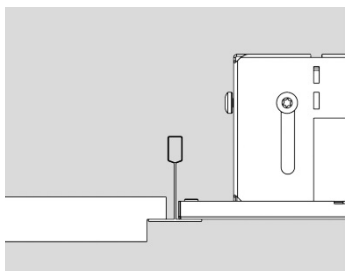

C63-R

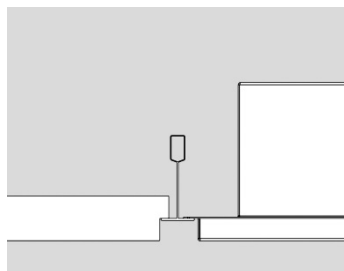

C91-RE (Kun på forespørgsel)

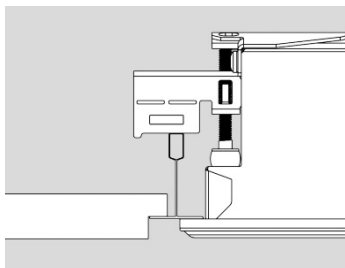

C64-R

Kan kun monteres nedefra i skinnesystem ved hjælp af armaturets indbyggede beslag (for at opretholde den høje IP-klasse).

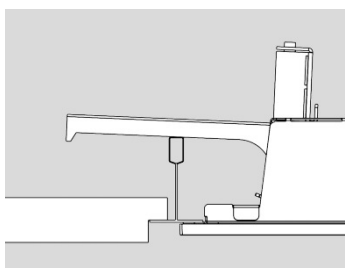

C70-R G2  
(+ MNT C70-R G2)

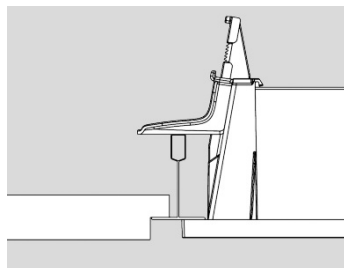

C90-R  
(+ MNT C90-R)

Ønskes montering nedefra, anbefales at bruge C70-R G2 eller C90-R. Monteringssæt er nødvendig som ekstra tilbehør.

---

## Synligt skinneresystem med kantede loftplader

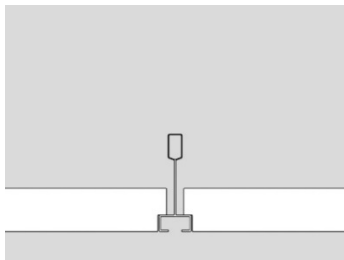

Armstrong Silhouette

### Eksempel på leverandører

Armstrong Silhouette, OWA S 15B OWAline, Rockfon E15 Microline, SAS 130

### Vores tilpassede løsninger

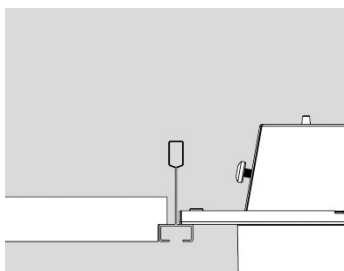

A51-R G2

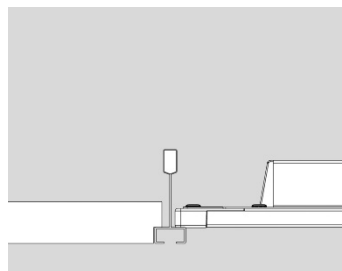

C77-R

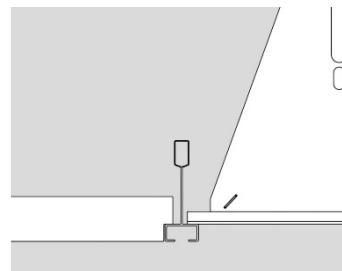

C30-RIT G2

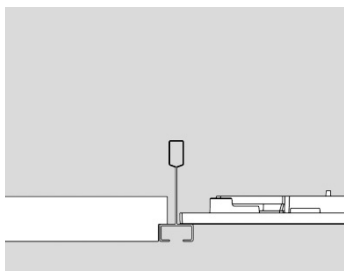

C70-R G2

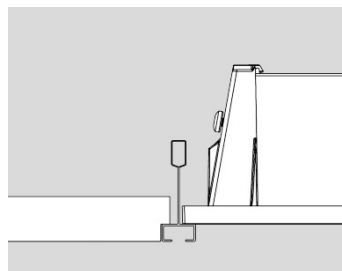

C90-R

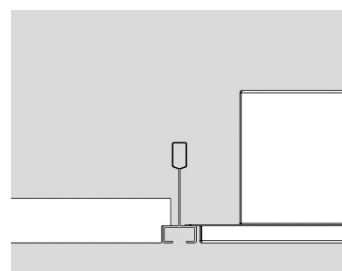

C91-RE (Kun på forespørgsel)



## Skjult skinnesystem med symmetriske loftplader

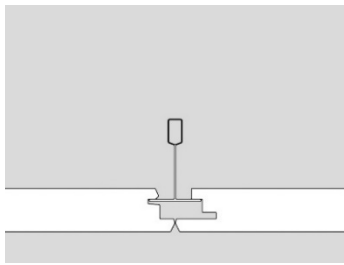

Ecophon Focus Ds

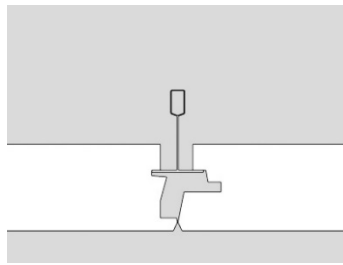

Ecophon Master Ds

## Eksempel på leverandører

Burgess Sequence Shiplap T24, Ecophon Focus/Master Ds, Paroc D2, Rockfon T24X

## Vores tilpassede løsninger

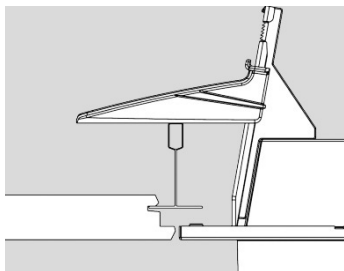

A51-R G2  
(+ MNT C20-R G2)

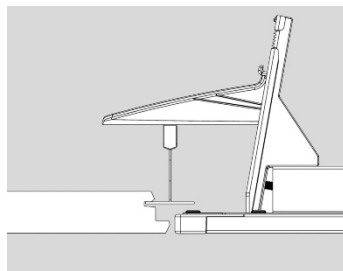

C77-R  
(+ MNT C77-R)

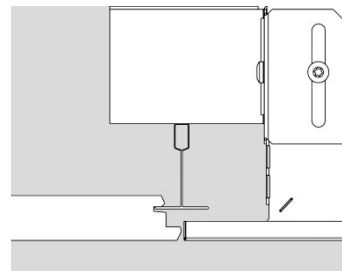

C30-RIC G2

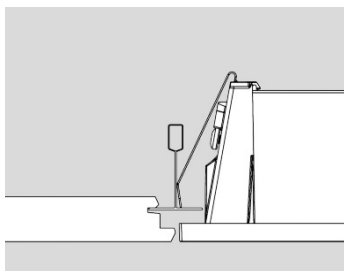

C90-R  
(+ MNT CLICK-IN C90-R)

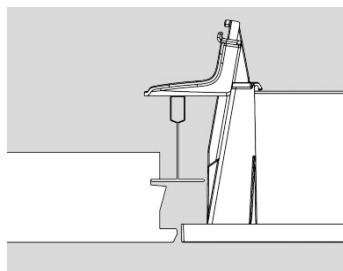

C90-R  
(+ MNT C90)

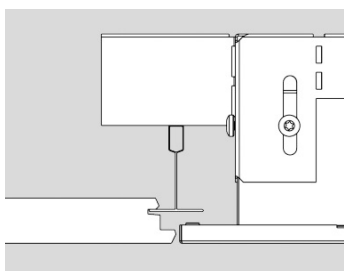

C91-R/C63-R

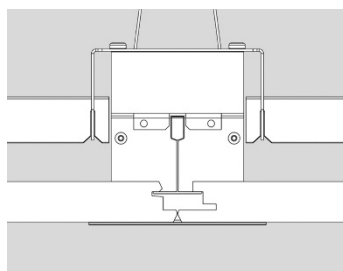

C80-R G2  
(+MNT DS/T24X)

## Skjult 24 mm skinnesystem med asymmetriske loftplader

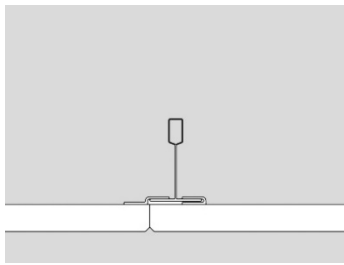

Gyproc Gyptone D1

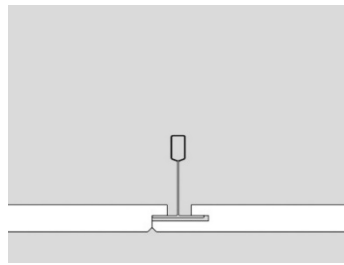

Gyproc Gyptone D2

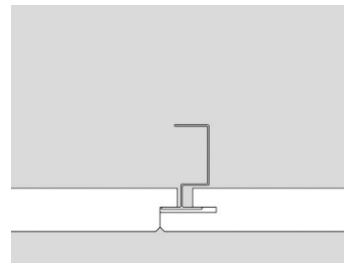

Rockfon D-XL

### Eksempel på leverandører

AMF AW, Gyproc Gyptone D1/D2, Knauf Danoline D/D+, OWA S 9b, Paroc D, Rockfon D-XL/H

### Vores tilpassede løsninger

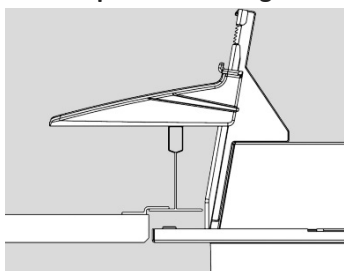

A51-R G2  
(+ MNT C20-R G2)

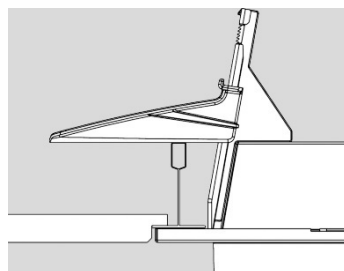

A51-R G2  
(+ MNT C20-R G2)

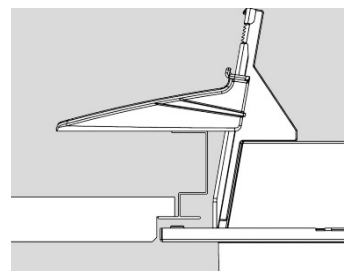

A51-R G2  
(+ MNT C20-R G2)

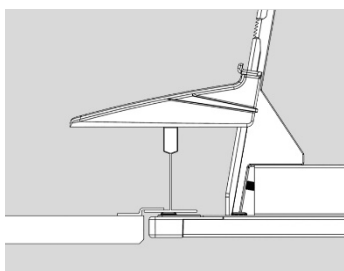

C77-R  
(+ MNT C77-R)

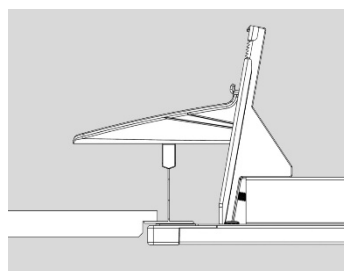

C77-R  
(+ MNT C77-R)

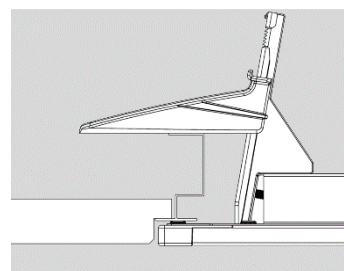

C77-R  
(+ MNT C77-R)

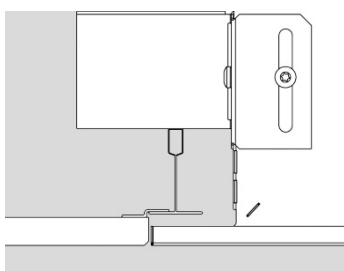

C30-RIC G2

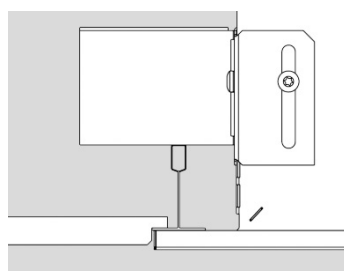

C30-RIC G2

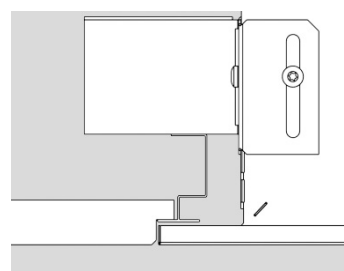

C30-RIC G2

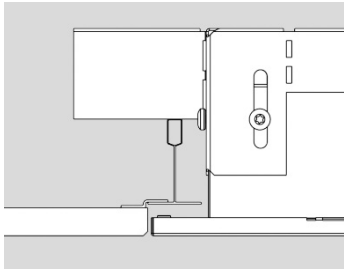

C91-R/C63-R

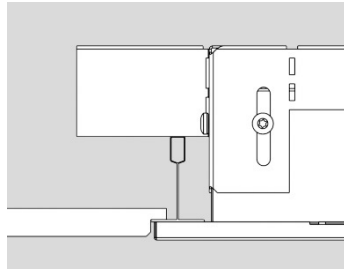

C91-R/C63-R

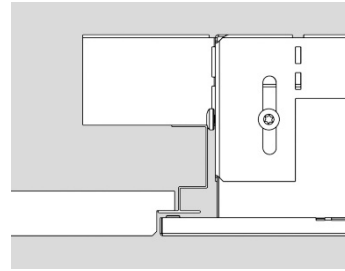

C91-R/C63-R

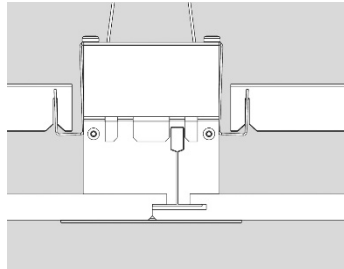

C80-R G2  
(+MNT GYPTONE D2)

## Skjult 35 mm skinneresystem med asymmetriske loftplader

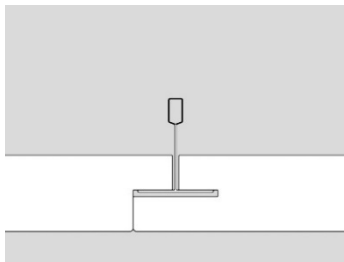

Troldekt T35

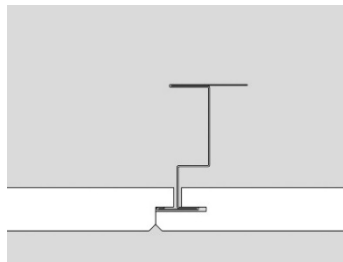

OWA S 9a

### Eksempel på leverandører

INLOOK VK-10, Troldekt K5-FN 35, OWA S 9a

### Vores tilpassede løsninger

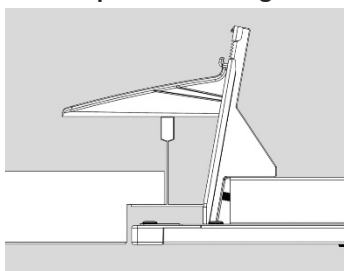

C77-R  
(+ MNT C77-R)

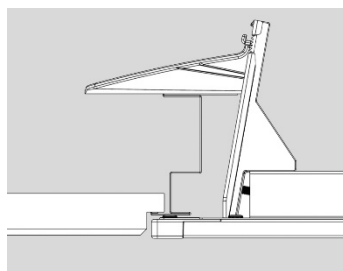

C77-R  
(+ MNT C77-R)

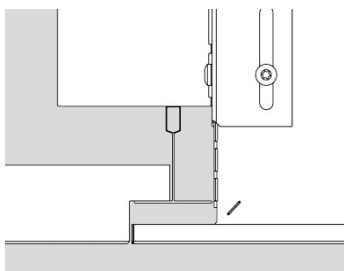

C30-RIC G2

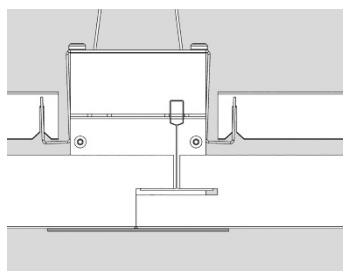

C80-R G2  
(+MNT TROLDTEKT T35)

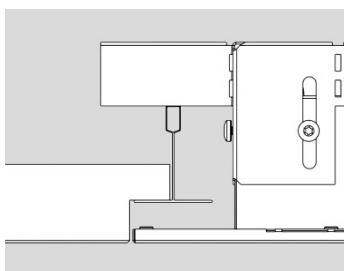

C92-R

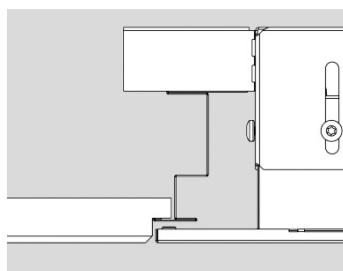

C92-R

## Bæreskinne 16 mm

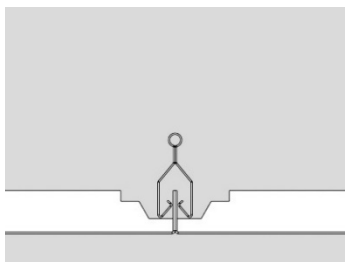

OWA S 22

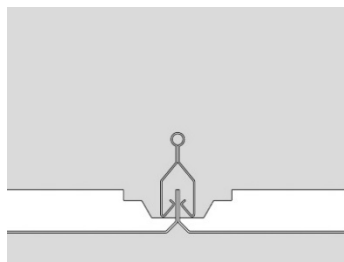

Lofterne kan leveres i 47, 52, 59 eller 67 mm højde med enten skarp eller faset kant.

## Eksempel på leverandører

Armstrong Q-Clip/R-Clip/S-Clip F, Burgess Clip In A-Bar, Fural K, Lindner LMD-K 420, OWA S 22/31/32, SAS 150

## Vores tilpassede løsninger

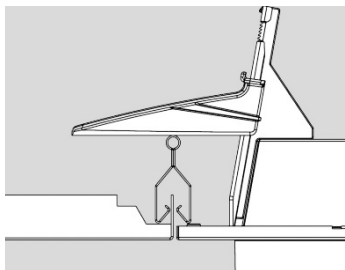

A51-R G2  
(+ MNT C20-R G2)

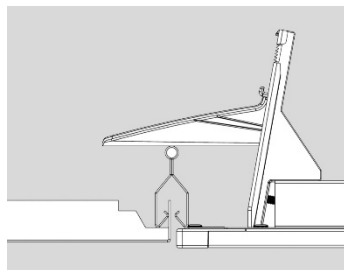

C77-R  
(+ MNT C77-R)

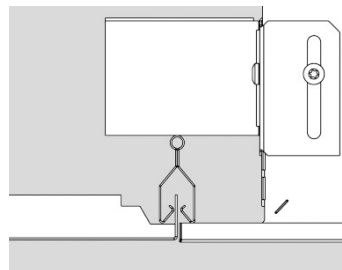

C30-RIC G2

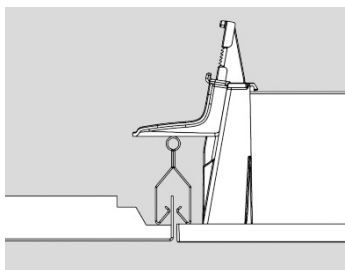

C90-R  
(+ MNT C90)

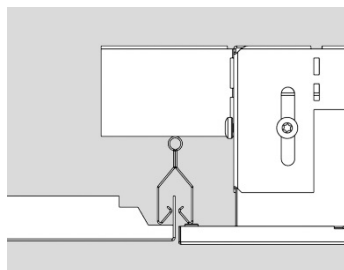

C91-R/C63-R

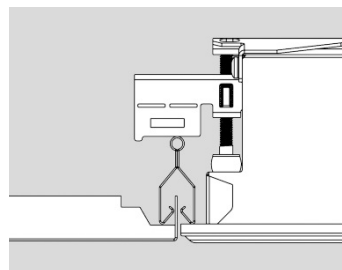

C64-R

## Bæreskinne 36 mm

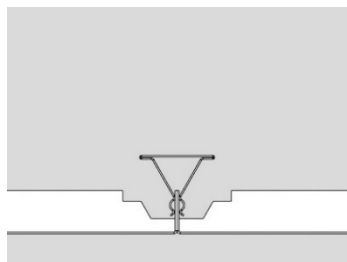

Dampa Clip-In

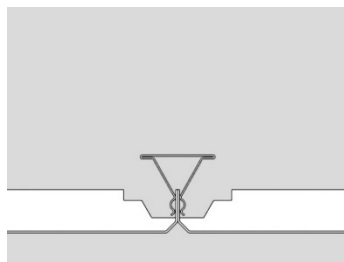

Lofterne kan leveres i 36  
(Dampa Clip-In / Meta Klemkassett)  
eller 45 mm højde  
(Armstrong T-Clip F / SAS 120)  
med enten skarp eller faset kant.

## Eksempel på leverandører

Armstrong T-Clip F, Dampa Clip-In, Meta Klemkassett, SAS 120

## Vores tilpassede løsninger

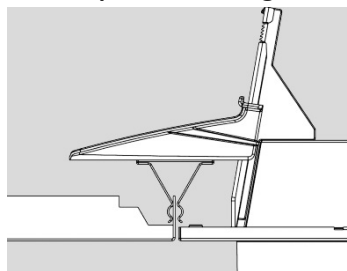

A51-R G2  
(+ MNT C20-R G2)

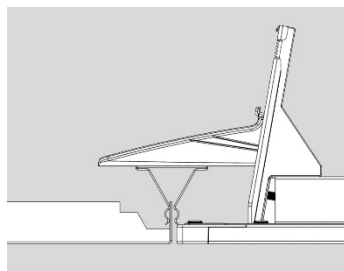

C77-R  
(+ MNT C77-R)

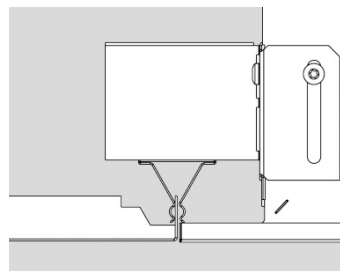

C30-RIC G2

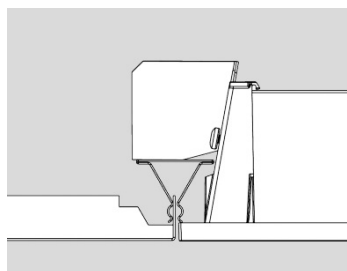

C90-R  
(+ MNT SPRING-T36 C90-R)

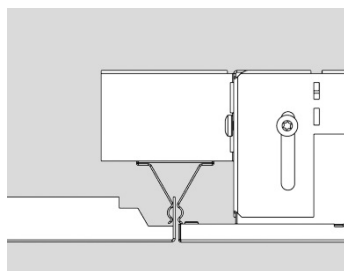

C91-R/C63-R

## Bæreskinne 45 mm

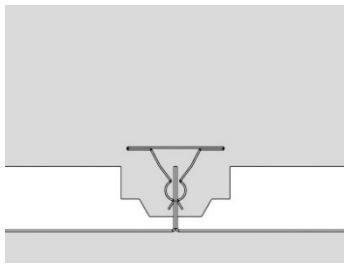

Burgess Clip-In

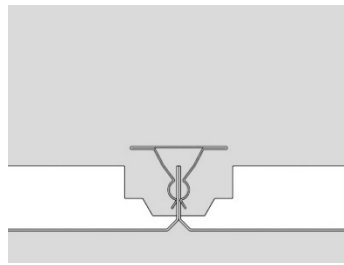

Lofterne kan leveres i 39 (Burgess Clip-In) eller 45 mm højde (Armstrong Orcal 1800/Burgess Clip-In) med enten skarp eller faset kant.

## Eksempel på leverandører

Armstrong Orcal 1800, Burgess Clip-In

## Vores tilpassede løsninger

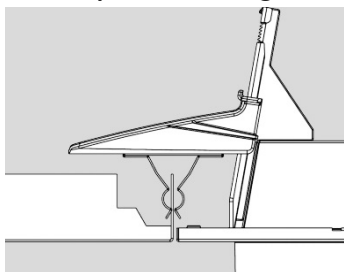

A51-R G2  
(+ MNT C20-R G2)

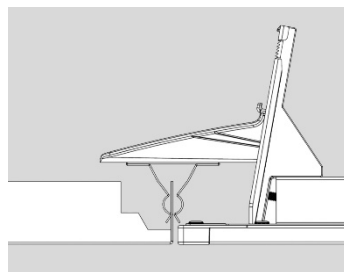

C77-R  
(+ MNT C77-R)

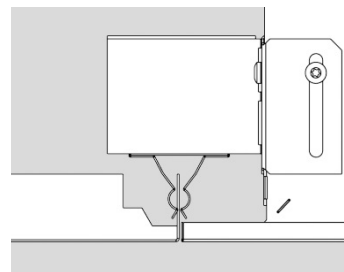

C30-RIC G2

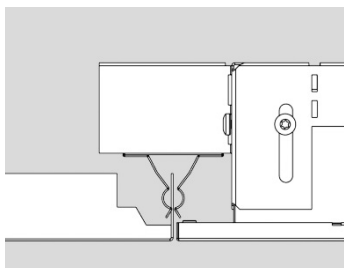

C91-R/C63-R

## Ikke demonterbare

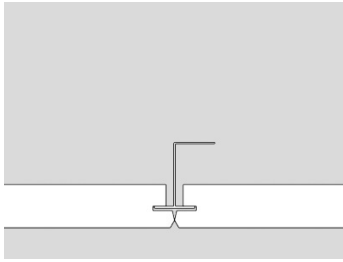

Rockfon C

## Eksempel på leverandører

AMF GN, Rockfon C

## Vores tilpassede løsninger

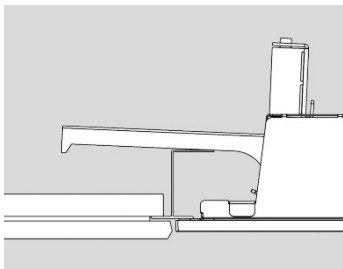

C70-R G2

(+ MNT C70-R G2)



# Gipslofter

Lifter som ikke er modulære, hvor et hul i loftet må tilpasses armaturets udforming.

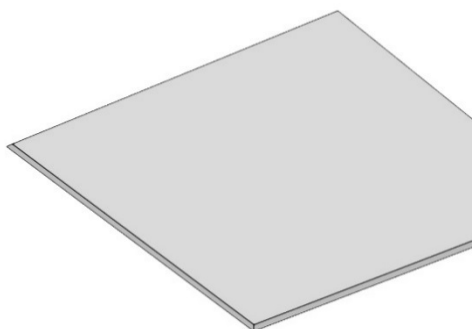

Tilpasset hul i loft



Gipsloft

## Vores tilpassede løsninger

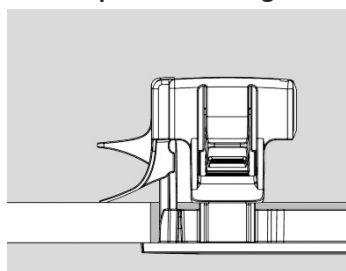

MNT FRAME PLASTERBOARD

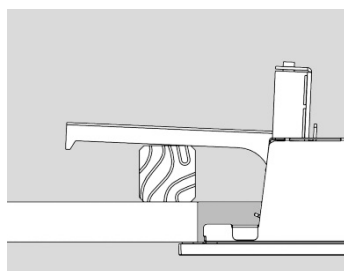

C70-R G2  
(+ MNT C70-R G2)

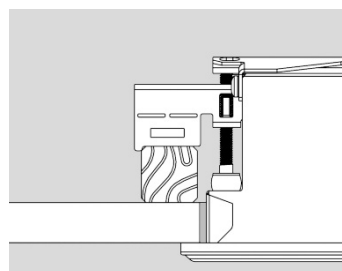

C64-R

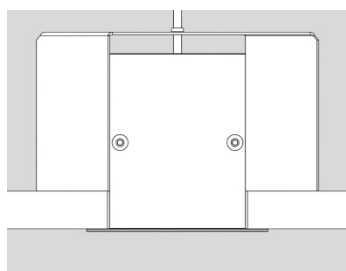

C80-R G2

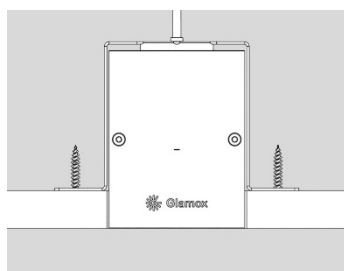

C80-S G2  
(+MNT TRIMLESS)

# Panellofter, flåde

Lofter med store synlige skinnesystemer hvor de korte ender af loftpladerne hviler på. Bæreprøferne har forskellige bredder og udforming, samt at længderne mellem disse varierer.

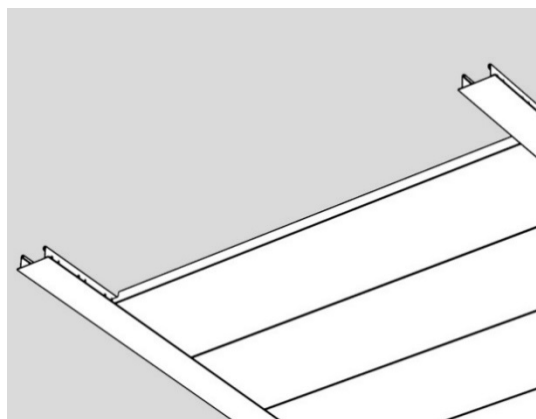

Liggende

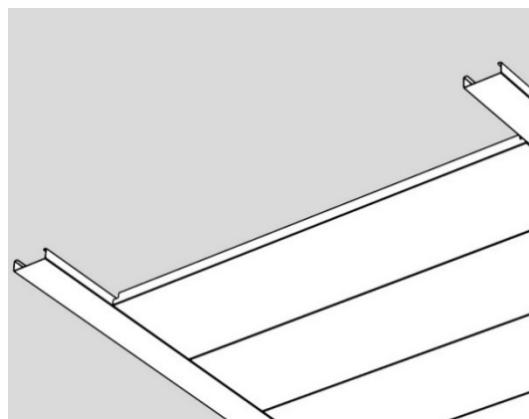

Hængende

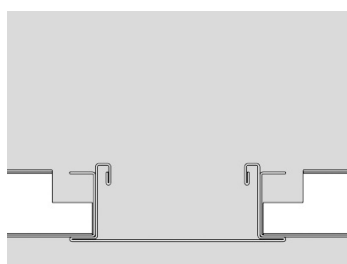

Armstrong liggende

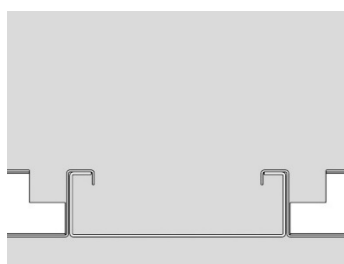

Armstrong nedhængt

## Eksempel på leverandører

Armstrong linear grid, SAS 330

## Vores tilpassede løsninger

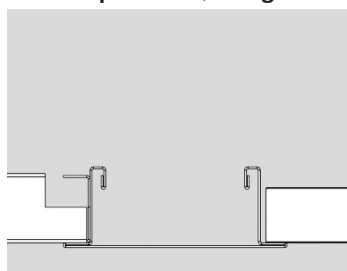

C95-R

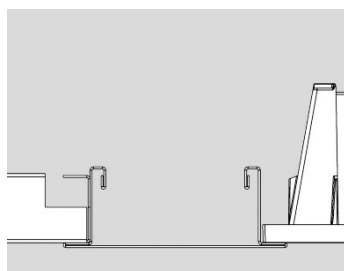

C90-R

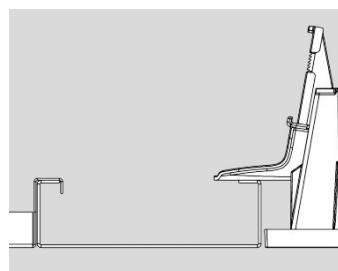

C90-R  
(+ MNT C90-R)

For liggende version med loftplader 300 x 1200 eller 312 x 1250 mm, anbefaler vi at bruge C95-R, C90-R eller C63-R. For hængende version passer C90-R eller C63-R bedst.

# Panellofter

Lineære loftsystemer findes i flere modulbredder (normalt 100, 150, 200 og 300 mm) som kun har begrænsninger i en retning (på tværs). Loftstykkerne er profilerede på hver side, enten i åbent eller i lukket udførelse. Loftstykkerne varierer meget i både højde og udformning.

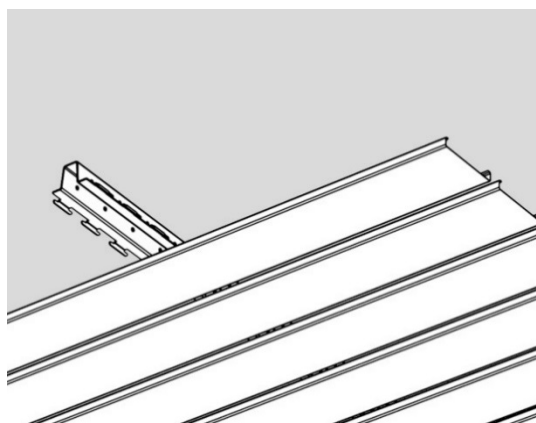

Åbent loftsystem

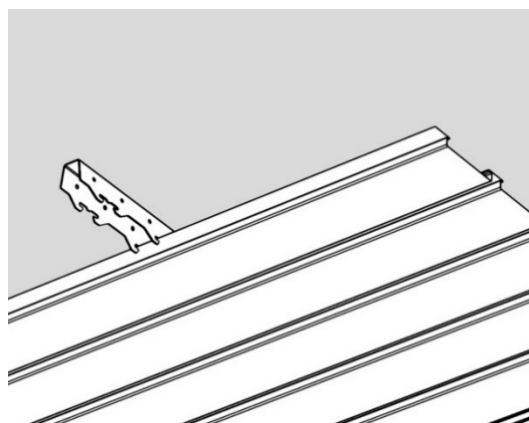

Lukket loftsystem

---

## Eksempel på leverandører

Dampa, Hunter Douglas

## Mulige løsninger

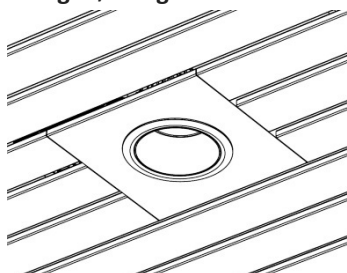

D70-R

Da loftsystemerne har så mange forskellige udførelser, anbefaler vi at benytte indbyggede downlights eller andre løsninger, for eksempel nedhængte armaturer.



# Glamox Koncernen

---

Glamox er en norsk industrikoncern, der udvikler, producerer og sælger professionelle belysningsløsninger til det globale marked. Vores mål er at levere bæredygtige belysningsløsninger, der forbedre menneskers ydeevne og velvære.

## Høj ydeevne og brugervenlighed

Vores løsninger er designet til at kombinere høj ydeevne og bæredygtighed med enkelhed og brugervenlighed, og dermed tilbyde en fremragende kundeoplevelse. Vi benytter de nyeste teknologier, der er baseret på generationers erfaring og tager fuldt ansvar for vores kunder og deres medarbejdere.

## Kvalitetsbrands og dedikeret support

Vi tilbyder løsninger fra en række anerkendte belysningsbrands. Uanset brand, er tæt opfølgning af hver kunde i fokus i vores virksomhed. Uanset om det er en produktionshal, et fiskefartøj eller en kontorbygning, er vores ambition at levere belysning som bidrager til et bedre liv for de virksomheder vi leverer til og de mennesker, som arbejder der.

