

Laesüsteemid



Sisukord

| | |
|---|-------------|
| Ülevaade | 3 |
| Moodullaed | 4-16 |
| T-profiilile paigaldatav | 4-5 |
| T-profiillaed astmega | 6-7 |
| T-profiillaed astmega plaatidega | 8 |
| Sümmeetrilised varjatud T-profiillaed eemaldatavate plaatidega | 9 |
| Asümmeetrilised varjatud 24 mm T-profiillaed eemaldatavate plaatidega | 10-11 |
| Asümmeetrilised varjatud profiiliga 35 mm T-profiillaed mitteavatavate plaatidega | 12 |
| Varjatud A-profiilid 16 mm | 13 |
| Varjatud vedru-T 36 mm | 14 |
| Varjatud vedru-T 45 mm | 15 |
| Mitteavatavad | 16 |
| Kipsplaatlaed | 17 |
| Pikipaneellaed varjatud otsaga | 18 |
| Pikipaneellaed | 19 |

Ülevaade

| | | MOODULLAED | | | | | | | | | | | Kipsplaatlaed | |
|--|-----------|-------------------|-------|----------------|----------------|----------------|--------------------|----------------|----------------|----------------|----------------|----------------|----------------|---------------------|
| | | LAHTIVÕETAVAD | | | | | | | | | | | | Mitte lahtivõetavad |
| | | NÄHTAVA PROFILIGA | | | | | VARJATUD PROFILIGA | | | | | | | |
| | | 15-24 mm | 35 mm | 15-24 mm | 15-24 mm | 15 mm | 24 mm | Asy 24 mm | Asy 35 mm | 16 mm | 36 mm | 45 mm | | 24 mm |
| | A51-R G2 | ✓ | ✓ | ✓ | ✓ | ✓ | ✓ ¹ | ✓ ¹ | | ✓ ¹ | ✓ ¹ | ✓ ¹ | | |
| | C25-R G2 | ✓ | ✓ | ✓ | ✓ | ✓ | | | | | | | | ✓ ³ |
| | C30RIT G2 | ✓ | ✓ | ✓ | ✓ | ✓ | | | | | | | | ✓ ³ |
| | C30RIC G2 | | | | | | ✓ | ✓ | ✓ | ✓ | ✓ | ✓ | | |
| | C63-R | ✓ | ✓ | ✓ | ✓ | | ✓ | ✓ | | ✓ | ✓ | ✓ | | |
| | C64-R | ✓ | | ✓ | ✓ | | ✓ | | | ✓ | | | ✓ | ✓ |
| | C70R G2 | ✓ | ✓ | ✓ | ✓ | ✓ | | | | | | ✓ ² | | ✓ ² |
| | C77-R | ✓ | ✓ | ✓ | ✓ | ✓ | ✓ ¹ | ✓ ¹ | ✓ ¹ | ✓ ¹ | ✓ ¹ | ✓ ¹ | | ✓ ³ |
| | C80R G2 | ✓ | | | | | ✓ ¹ | ✓ ¹ | ✓ ¹ | | | | | ✓ |
| | C90R | ✓ | ✓ | ✓ | ✓ | ✓ | ✓ ¹ | | | ✓ ¹ | ✓ ¹ | | | ✓ ³ |
| | C91-R | | | | | | ✓ | | | | ✓ | | | |
| | C91-RE | | | ✓ ⁴ | ✓ ⁴ | ✓ ⁴ | | | | | | | | |
| | C92-R | | | | | | | ✓ | | | | | | |
| | C95-R | ✓ | ✓ | ✓ | ✓ | ✓ | ✓ ¹ | ✓ ¹ | | ✓ ¹ | ✓ ¹ | ✓ ¹ | ✓ ¹ | ✓ ³ |
| | MODERNA2R | ✓ | ✓ | ✓ | ✓ | ✓ | | | | | | | | ✓ ^{1/3} |

1 - Paigaldusklambrid lisavarustusena
2 - Paigaldusraam lisavarustusena

3 - Kipsplaatlakke süvistusraamiga
4 - Ainult küsimisel

Moodullaed

Moodullagede süsteemidel on kindlad pikkused ja laiused, seda nii profiilile asetatavate-, kui peidetud profiiliga laeprofiilide korral.

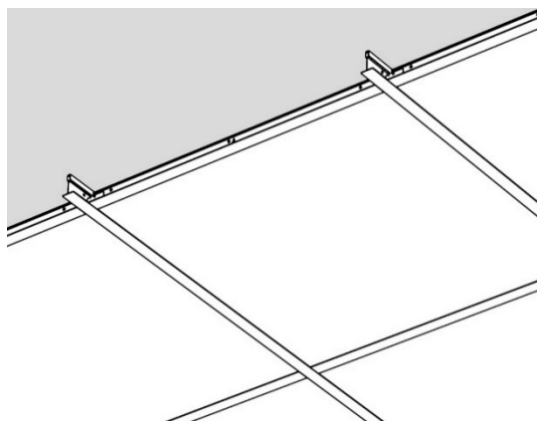

T-profiilile paigaldus

T-profiilile paigaldus

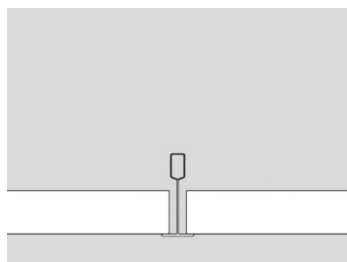

Ecophon A15

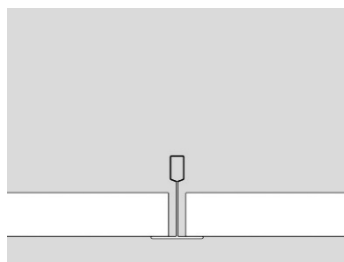

Ecophon A24

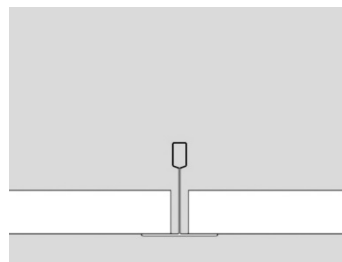

Armstrong Prelude 35

Tootjate näited

AMF SK 15/24, Armstrong Prelude 15/24/35, Burgess Sequence 15/24, Ecophon A15/24, Gyproc Gyptone A15/24, Knauf Danoline A, Lindner LMD-K 403, OWA S 15/3, Paroc A, Rockfon A15/24, Trolldtekt K0-S 35

Meie sobilikud lahendused

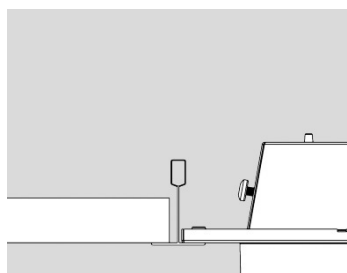

A51-R G2

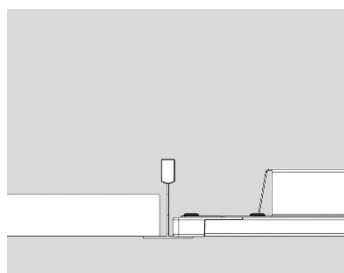

C77-R

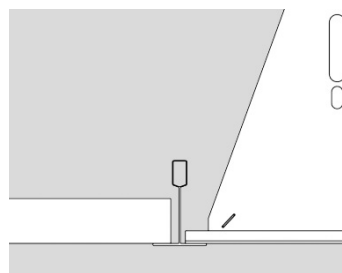

C30-RIT G2

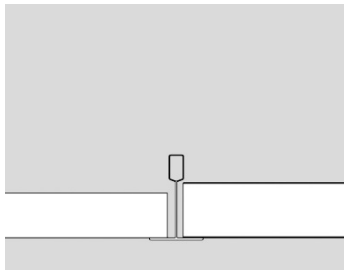

C25-R/C35-R/C95-R
MODERNA2-R

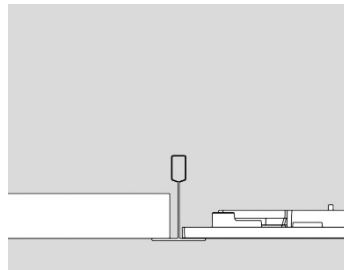

C70-R G2

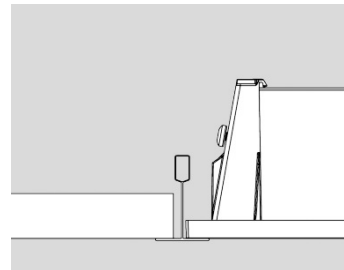

C90-R

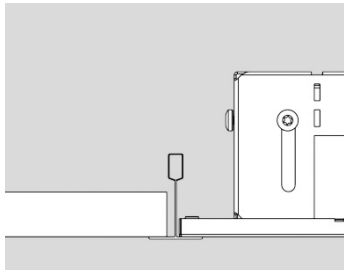

C63-R

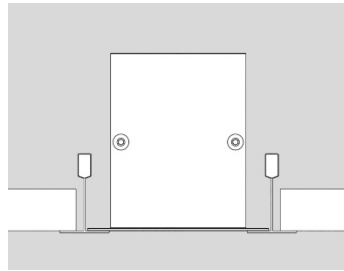

C80-R G2

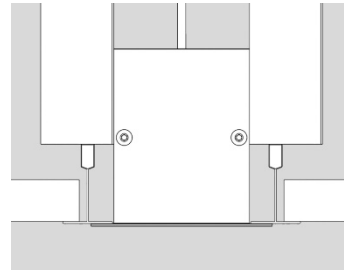

C80-R G2

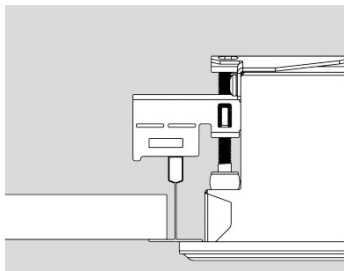

C64-R

Saab paigaldada T-profilist allpoolt, kasutades valgustile paigaldatud kinnitust.

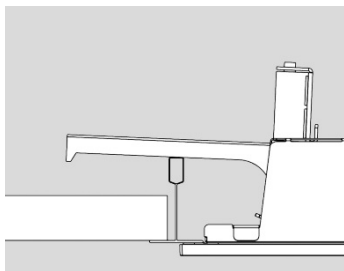

C70-R G2/C85-R
(+ MNT C70-R G2)

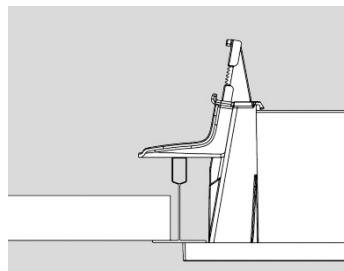

C90-R
(+ MNT C90-R)

Kui soovid paigaldada valgusteid T-profilist altpoolt, soovime kasutada C70-R G2 või C90-R. Need vajavad paigalduskomplekti, mis saadaval lisatarvikuna.

T-profiillaed astmelise servaga plaadiga

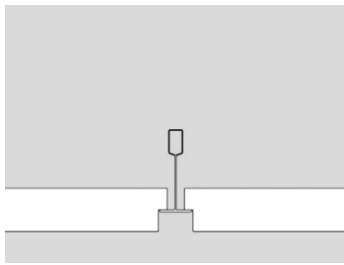

Rockfon E15S

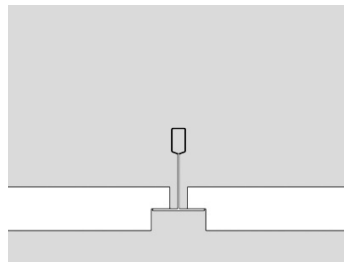

Rockfon E24S

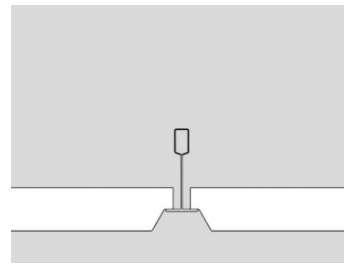

Astmelise servaga plaadid erinevadisaini ja sügavuse poolest, siin näidatud Rockfon E15L

Tootjate näited

AMF VT 15/24, Armstrong Prelude 15/24, Burgess Sequence 15/24, Ecophon E15/24, Gyproc Gyptone E15, Knauf Danoline E/E+, Lindner LMD-K 400, OWA S 15A/3A, Paroc E15/E24, Rockfon E15/24, Trolldtekt K0/K3/K5-FS 35

Meie sobilikud lahendused

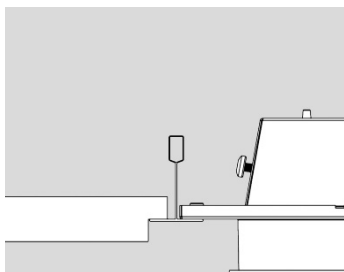

A51-R G2

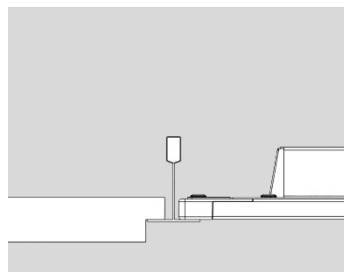

C77-R

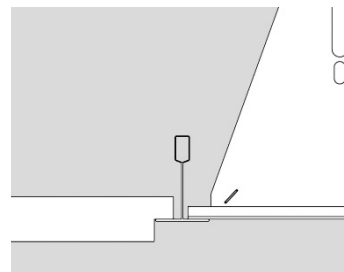

C30-RIT G2

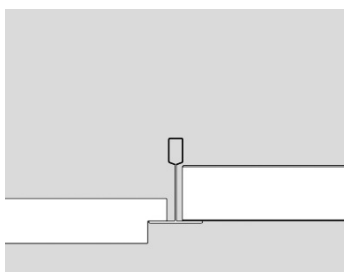

C25-R/C35-R/C95-R
MODERNA2-R

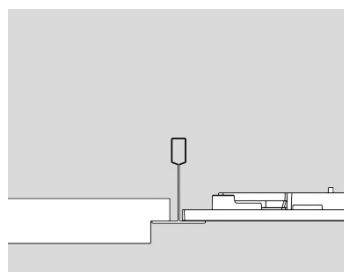

C70-R G2

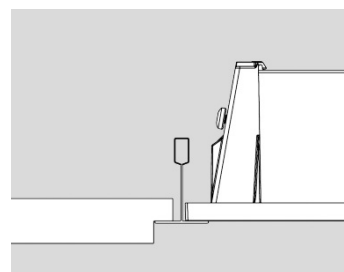

C90-R

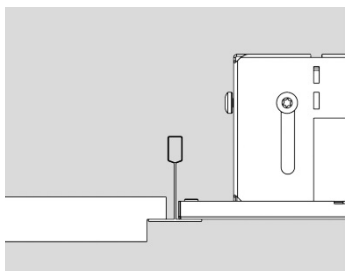

C63-R

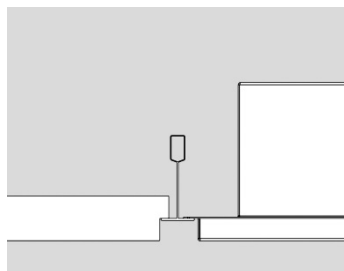

C91-RE (Vaid küsimisel)

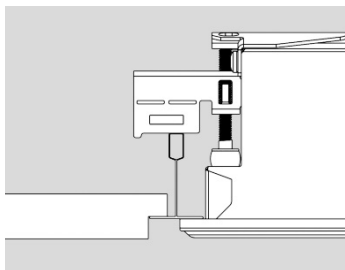

C64-R

Saab paigaldada T-profilist allpoolt, kasutades valgustile paigaldatud kinnitust.

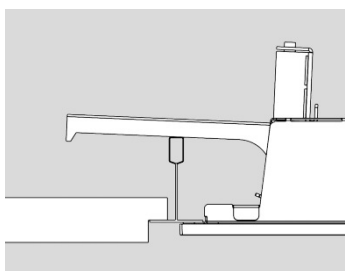

C70-R G2
(+ MNT C70-R G2)

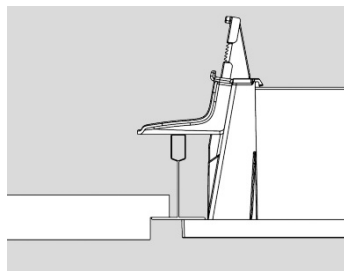

C90-R
(+ MNT C90-R)

Kui soovid paigaldada valgusteid T-profilist altpoolt, soovitame kasutada C70-R G2 või C90-R. Need vajavad paigalduskomplekti, mis saadaval lisatarvikuna

T-profiillaed astmelise servaga plaadiga

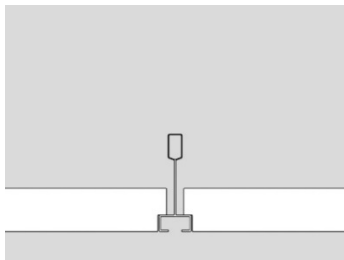

Armstrong Silhouette

Tootjate näited

Armstrong Silhouette, OWA S 15B OWAline, Rockfon E15 Microline, SAS 130

Meie sobilikud lahendused

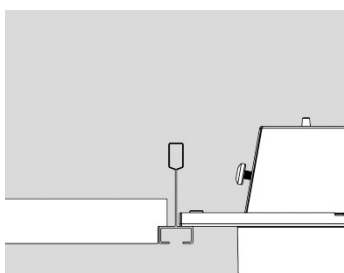

A51-R G2

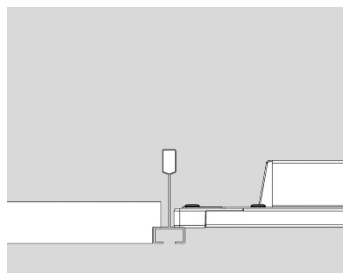

C77-R

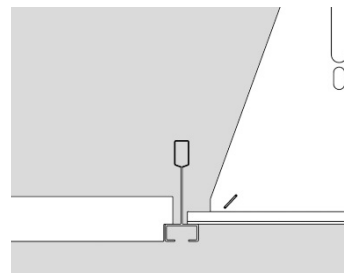

C30-RIT G2

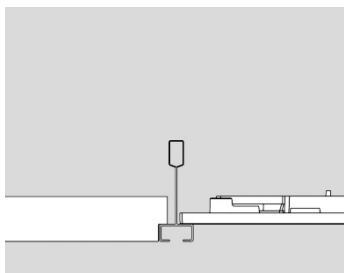

C70-R G2

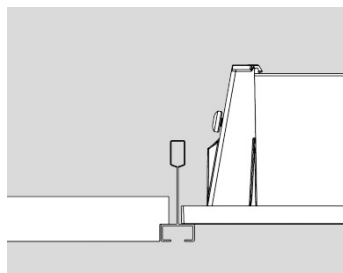

C90-R

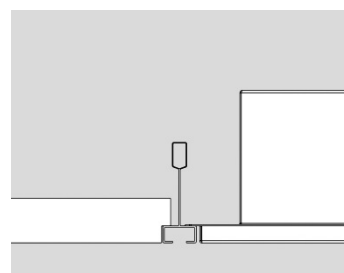

C91-RE (Vaid küsimisel)

Sümmeetrilised varjatud profiiliga T-profiillaed eemaldatavate plaatidega

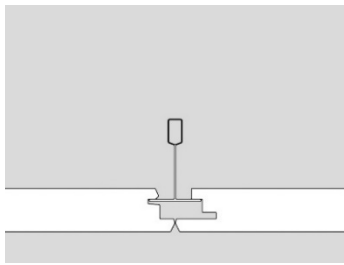

Ecophon Focus Ds

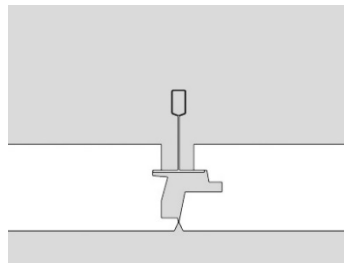

Ecophon Master Ds

Tootjate näited

Burgess Sequence Shiplap T24, Ecophon Focus/Master Ds, Paroc D2, Rockfon T24X

Meie sobilikud lahendused

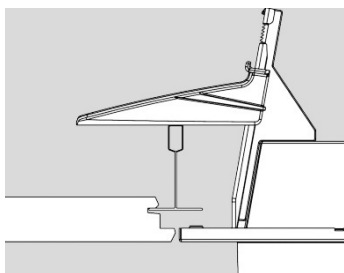

A51-R G2
(+ MNT C20-R G2)

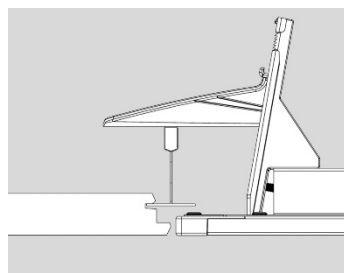

C77-R
(+ MNT C77-R)

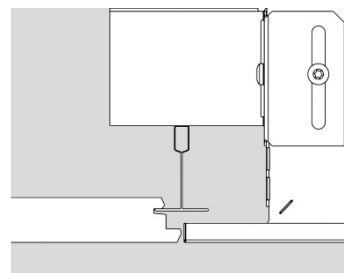

C30-RIC G2

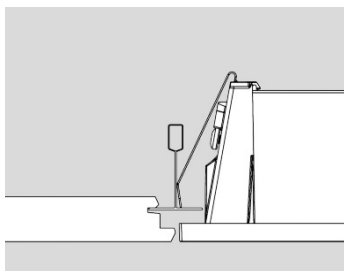

C90-R
(+ MNT CLICK-IN C90-R)

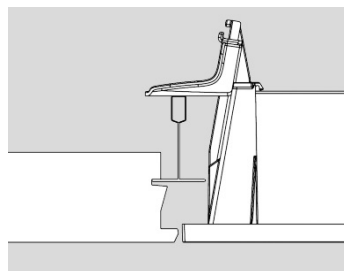

C90-R
(+ MNT C90)

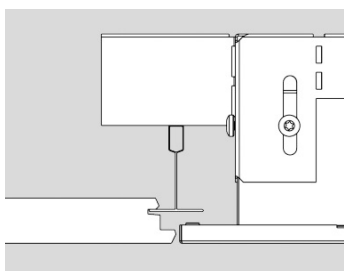

C91-R/C63-R

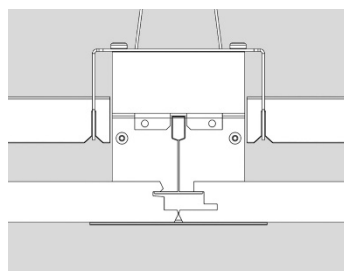

C80-R G2
(+MNT DS/T24X)

Asümmeetrilised varjatud profiiliga T-profiillaed eemaldatavate plaatidega

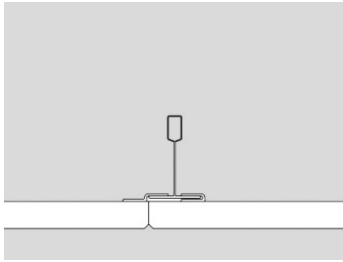

Gyproc Gyptone D1

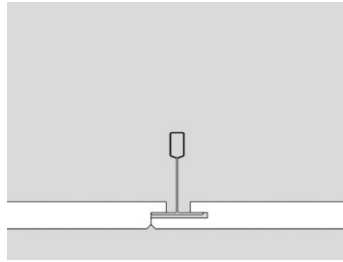

Gyproc Gyptone D2

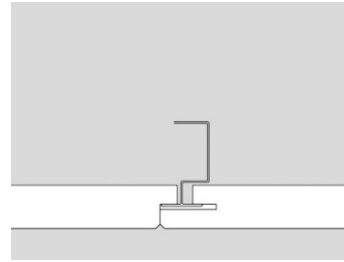

Rockfon D-XL

Tootjate näited

AMF AW, Gyproc Gyptone D1/D2, Knauf Danoline D/D+, OWA S 9b, Paroc D, Rockfon D-XL/H

Meie sobilikud lahendused

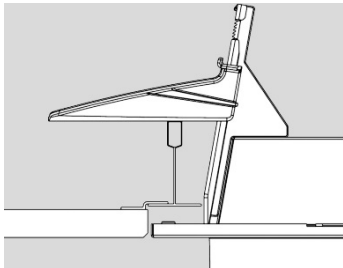

A51-R G2
(+ MNT C20-R G2)

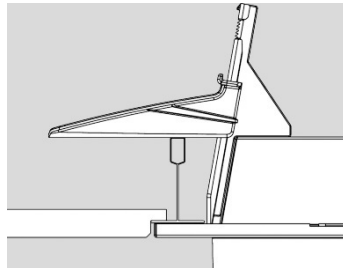

A51-R G2
(+ MNT C20-R G2)

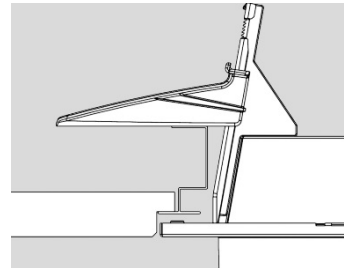

A51-R G2
(+ MNT C20-R G2)

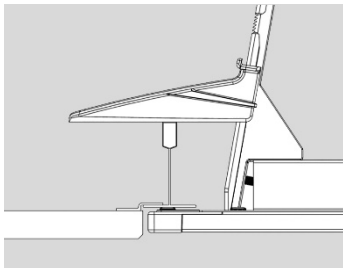

C77-R
(+ MNT C77-R)

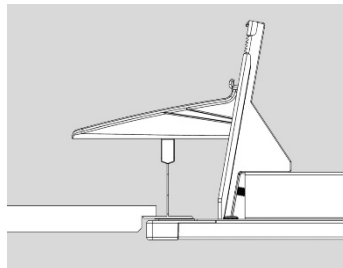

C77-R
(+ MNT C77-R)

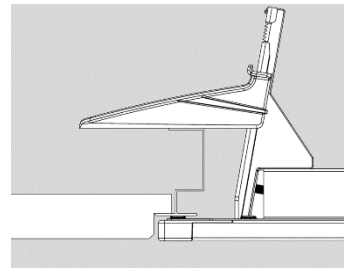

C77-R
(+ MNT C77-R)

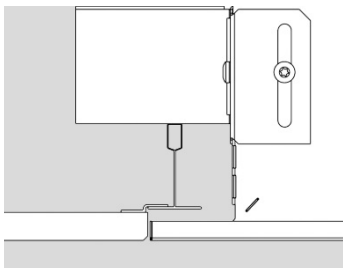

C30-RIC G2

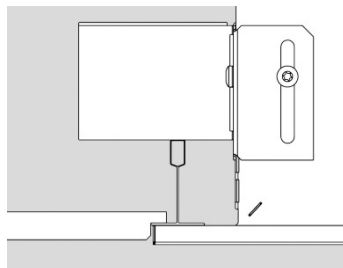

C30-RIC G2

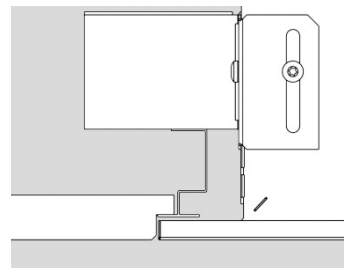

C30-RIC G2

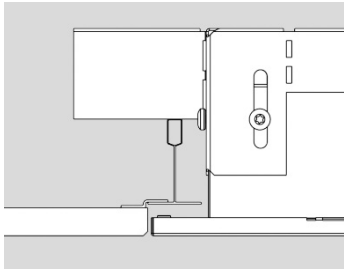

C91-R/C63-R

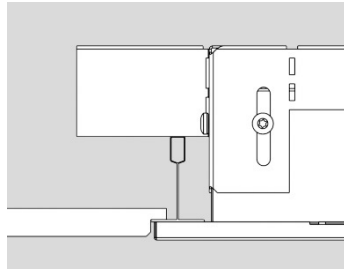

C91-R/C63-R

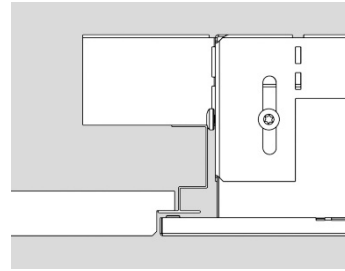

C91-R/C63-R

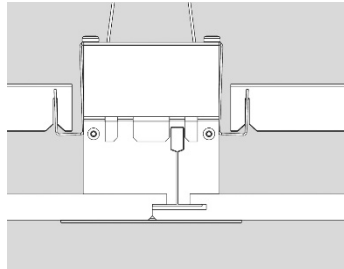

C80-R G2
(+MNT GYPTONE D2)

Asümmeetrilised varjatud profiiliga 35 mm T-profiillaed eemaldatavate plaatidega

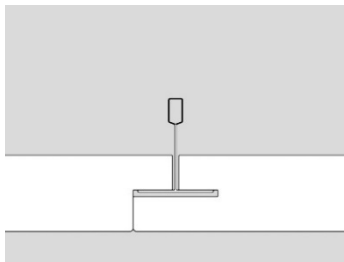

Troldekt T35

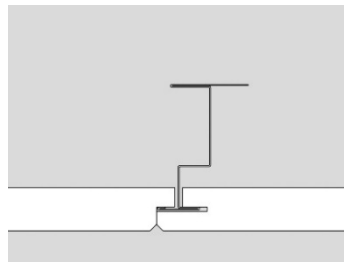

OWA S 9a

Tootjate näited

INLOOK VK-10, Troldekt K5-FN 35, OWA S 9a

Meie sobilikud lahendused

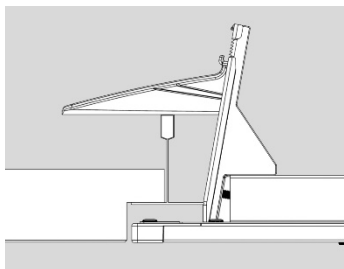

C77-R
(+ MNT C77-R)

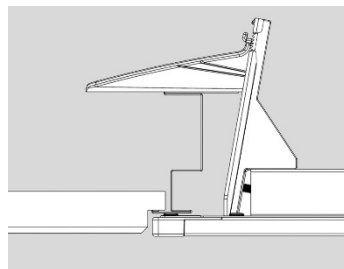

C77-R
(+ MNT C77-R)

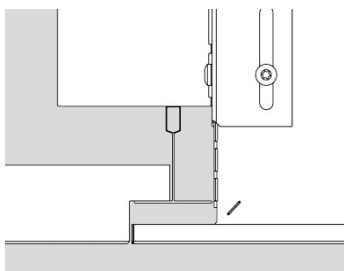

C30-RIC G2

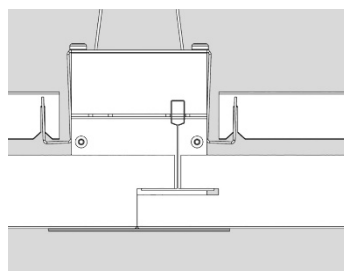

C80-R G2
(+MNT TROLDTEKT T35)

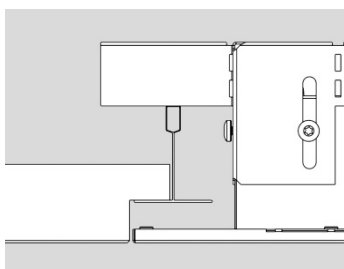

C92-R

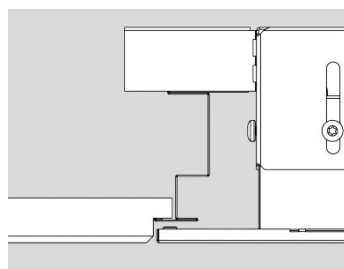

C92-R

Varjatud A-profiillagi 16 mm

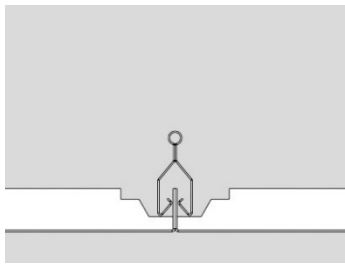

OWA S 22

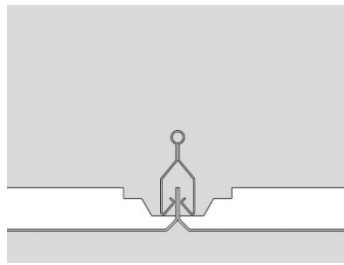

Saadaval on 47, 52, 59 või 67 mm kõrgused laesüsteemid nii täisnurkse- kui viltuse servaga

Tootjate näited

Armstrong Q-Clip/R-Clip/S-Clip F, Burgess Clip In A-Bar, Fural K, Lindner LMD-K 420, OWA S 22/31/32, SAS 150

Meie sobilikud lahendused

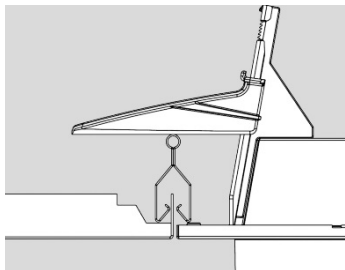

A51-R G2
(+ MNT C20-R G2)

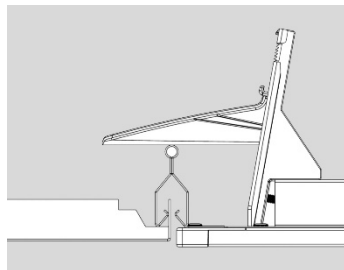

C77-R
(+ MNT C77-R)

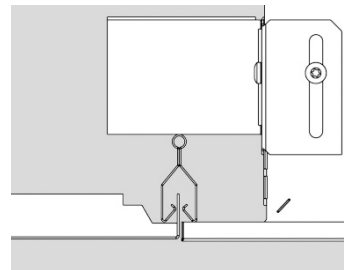

C30-RIC G2

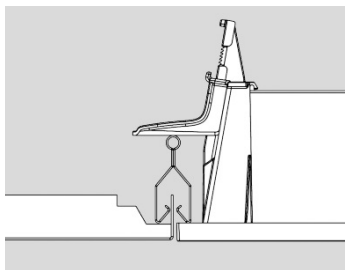

C90-R
(+ MNT C90)

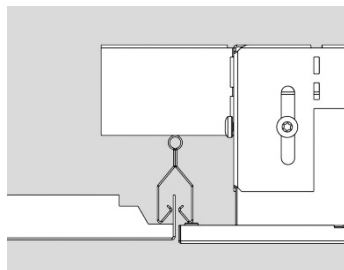

C91-R/C63-R

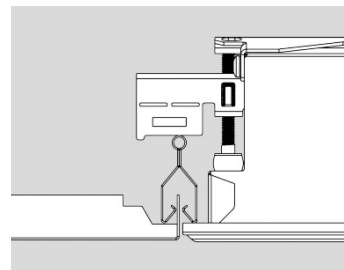

C64-R

Varjatud vedru-T 36 mm profiil

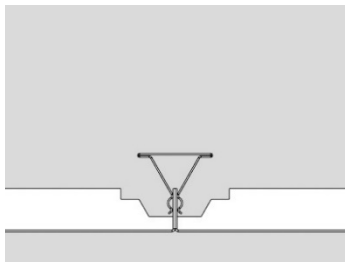

Dampa Clip-In

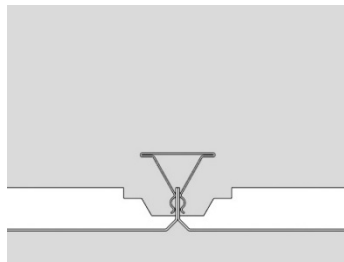

Saadaval on 36mm (Dampa Clip-In)
või 45mm kõrgune
(Armstrong T-Clip F / SAS 120)
nii täisnurkse- kui viltuse servaga.

Tootjate näited

Armstrong T-Clip F, Dampa Clip-In, Meta Klemkassett, SAS 120

Meie sobilikud lahendused

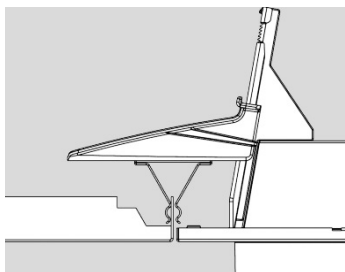

A51-R G2
(+ MNT C20-R G2)

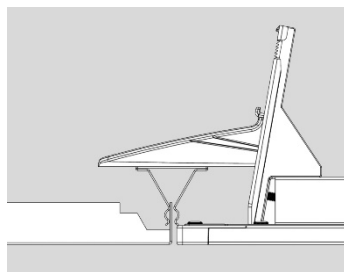

C77-R
(+ MNT C77-R)

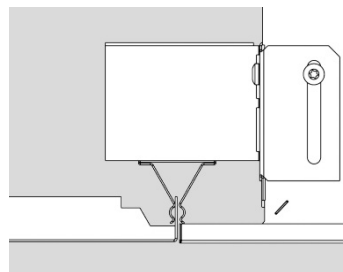

C30-RIC G2

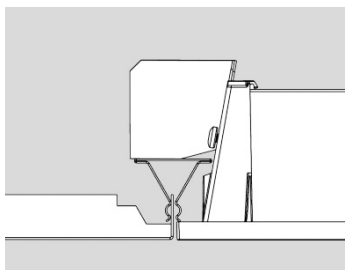

C90-R
(+ MNT SPRING-T36 C90-R)

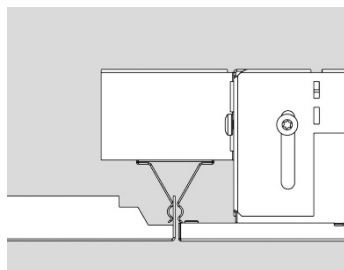

C91-R/C63-R

Varjatud vedru-T 45 mm profiil

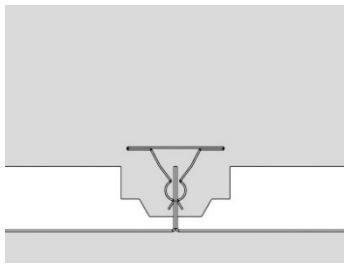

Burgess Clip-In

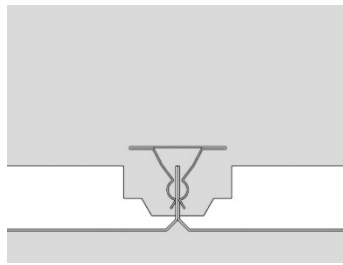

Saadaval on 39mm (Burgess Clip-In)
või 45mm kõrgune
(Armstrong Orcal 1800/Burgess Clip-In)
nii täisnurkse- kui viltuse servaga.

Tootjate näited

Armstrong Orcal 1800, Burgess Clip-In

Meie sobilikud lahendused

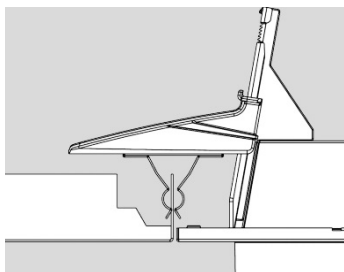

A51-R G2
(+ MNT C20-R G2)

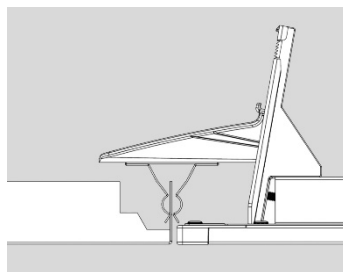

C77-R
(+ MNT C77-R)

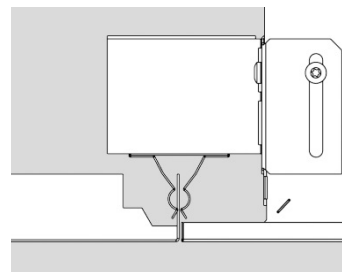

C30-RIC G2

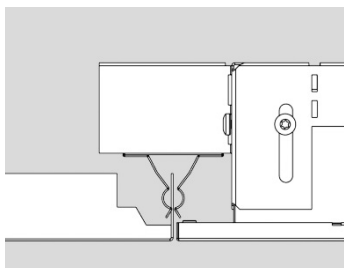

C91-R/C63-R

Lahtivõetamatud laesüsteemid

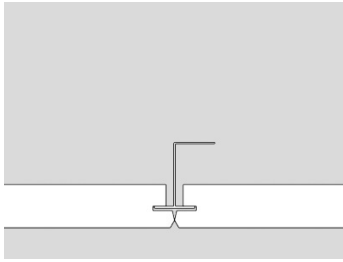

Rockfon C

Tootjate näited

AMF GN, Rockfon C

Meie sobilikud lahendused

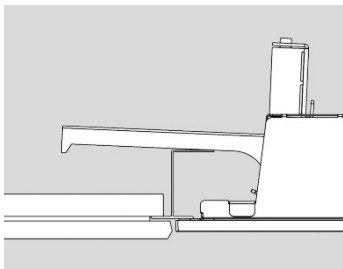

C70-R G2

(+ MNT C70-R G2)

Täisplaatlaed

Mittemoodullaed, kus valgusti paigaldusava peab sobima valgustiga.

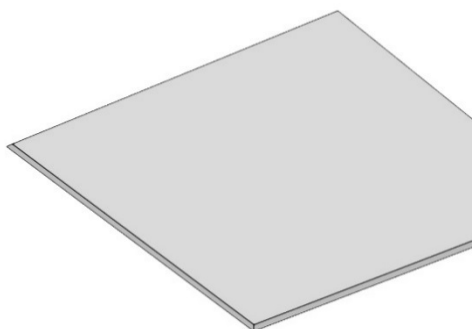

Kohandatud laeava

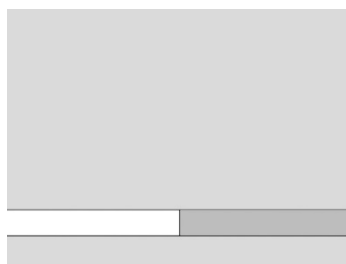

Kipsplaatlagi

Meie sobilikud lahendused

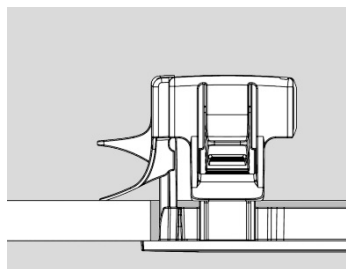

MNT FRAME PLASTERBOARD

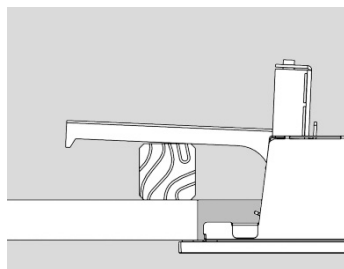

C70-R G2
(+ MNT C70-R G2)

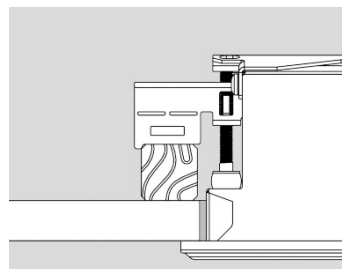

C64-R

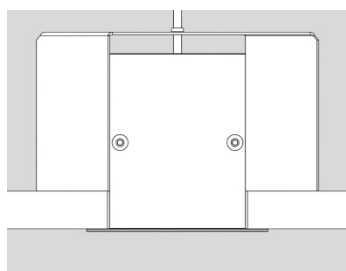

C80-R G2

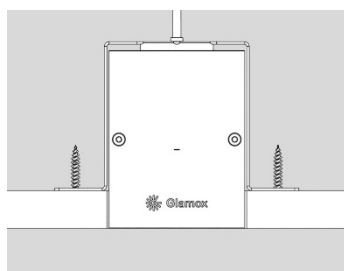

C80-S G2
(+MNT TRIMLESS)

Pikipaneellaed varjatud otsaga

Laed pikkade profiilidega, kus otsaservaga toetavad äärelüistule. Paneelid on eri laiuste ja disainiga, samuti eri pikkustega.

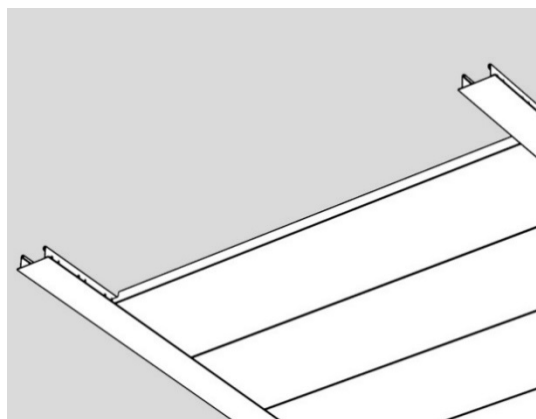

Peale asetatav

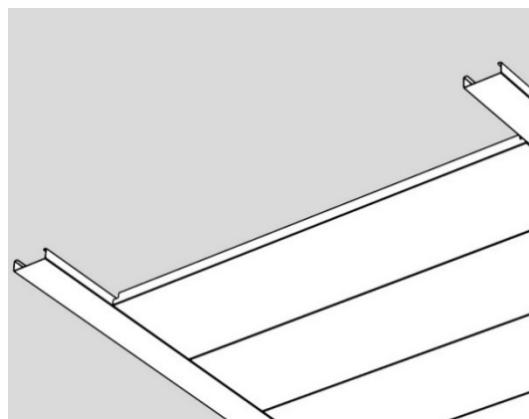

Konksu külge

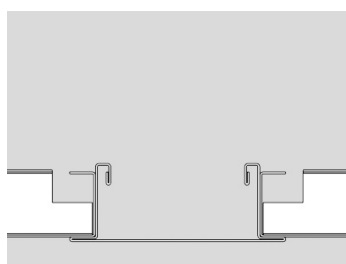

Armstrong peale asetatav

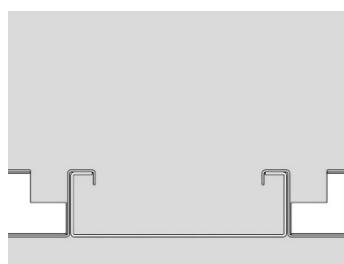

Armstrong kinnitatav

Tootjate näited

Armstrong linear grid, SAS 330

Meie sobilikud lahendused

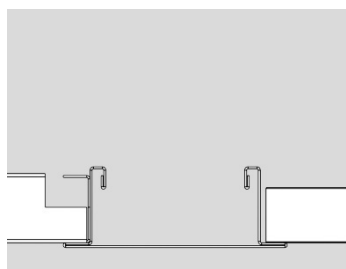

C95-R

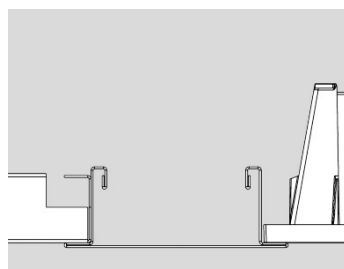

C90-R

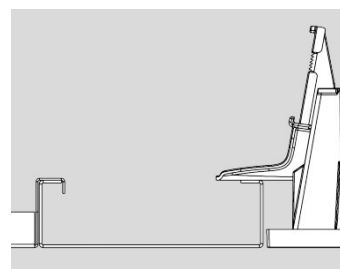

C90-R
(+ MNT C90-R)

Profiilile paigaldatavad versioonid plaadisuurustega 300 x 1200 või 312 x 1250 mm on sobilikud C95-R, C90-R või C63-R valgustitega. Konksuga lae korral sobivad C90-R ja C63-R.

Pikipaneellaed

Laepaneele on väga erinevate mooduli laiustega (tavaliselt 100, 150, 200 ja 300 mm) kus ainsaks piiranguks on pikkus. Paneelid on servadest painutatud, nii nii vahedega, kui ilma. Paneelid on väga erinevate kõrguste ja pikkustega

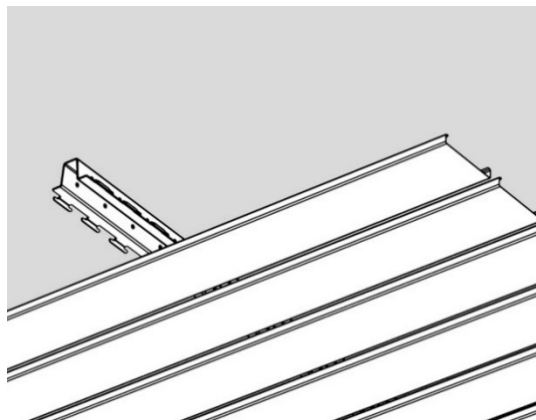

Avatava paneeliga

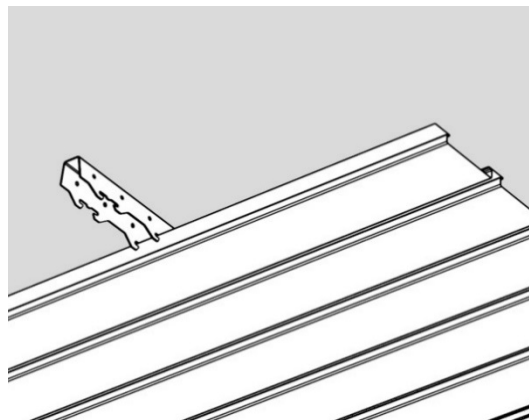

Suletud paneeliga

Tootjate näited

Dampa, Hunter Douglas

Võimalikud lahendused

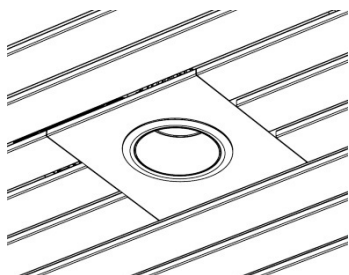

D70-R

Kuna paneellagesid on väga erinevaid, siis soovitame kasutada süvistatud allvalgusteid või teisi lahendusi, näiteks pinnapealseid valgusteid.



Glamoxi kontsern

Glamox on Norra tööstuskontsern, mis arendab, toodab ja müüb professionaalseid valgustuslahendusi globaalsele turule. Meie eesmärk on pakkuda jätkusuutlikke valguslahendusi, mis parandavad inimese jõudlust ja heaolu.

Kõrge jõudlus ja kasutusmugavus

Meie lahendused on loodud ühendama suure jõudluse ja jätkusuutlikkuse lihtsuse ja kasutusmugavusega, pakkudes ülimat kliendikogemust. Kasutame nutikalt uusimat tehnoloogiat ja pakume sellele põlvkondadepikkust kogemust ning tõelist hoolitsust oma klientide ja nende inimeste eest.

Kvaliteetsed kaubamärgid ja pühendunud tugi

Pakume oma lahendusi erinevate kvaliteetsete valgustibrändide kaudu. Olenemata kaubamärgist on iga kliendi hoolikas jälgimine meie pakkumise keskses. Olgu see tootmishoones, kalalaeval või büroohoones, meie eesmärk on pakkuda valgustust, mis aitab kaasa meie teenindatavate ettevõtete ja seal töötavate inimeste paremale elule.

Lisainfot leiate www.glamox.ee

